

# TOPCOM<sup>®</sup>

## BUTLER 3300/TWIN/ TRIPLE/QUATTRO



USER GUIDE

1.3



### **Important**

To use 'Caller ID' (display caller), this service has to be activated on your phone line. Normally you need a separate subscription from your telephone company to activate this function. If you don't have the Caller ID function on your phone line, the incoming telephone numbers will NOT be shown on the display of your telephone.

This product is in compliance with the essential requirements and other relevant provisions of the R&TTE directive 1999/5/EC.  
The Declaration of conformity can be found on :

<http://www.topcom.net/support/cedclarations.php>

To be connected to the public analogue telephone network.

The CE symbol indicates that the unit complies with the essential requirements of the R&TTE directive.

The features described in this manual are published with reservation to modifications.

<b>1</b>	<b>Buttons</b>	<b>5</b>
<b>2</b>	<b>Display</b>	<b>6</b>
<b>3</b>	<b>Installation</b>	<b>6</b>
3.1	Base	6
3.2	Multi charger	7
3.3	Handset	7
<b>4</b>	<b>Battery low indication</b>	<b>8</b>
<b>5</b>	<b>Operation</b>	<b>8</b>
5.1	Outgoing calls	8
5.2	Incoming calls	9
5.3	Activate/deactivate hands free function	9
5.4	Programming memory numbers	9
5.5	Calling a memory number	9
5.6	Mute function	9
5.7	Setting the volume	9
5.8	Paging	10
5.9	Flash button (R)	10
5.10	Setting the ring volume and melody	10
5.11	Key lock	11
5.12	Setting the dialling mode	11
<b>6</b>	<b>Caller-ID function (CLIP)</b>	<b>11</b>
6.1	New calls	11
6.2	Consulting the Call list	11
6.3	Calling a number from the Call list	12
6.4	Erasing a number from the Call list	12
6.5	Store a number from the call log into the memory	12
<b>7</b>	<b>Register/de-register a handset</b>	<b>12</b>
7.1	Register to a Topcom B3300 base	12
7.2	Subscribing a Topcom Butler 300 DECT GAP Headset	13
7.3	Removing a handset	13
<b>8</b>	<b>Call transfer and Intercom between two handsets</b>	<b>14</b>
8.1	Call transfer and conference call during an external call	14
8.2	Internal call (intercom)	14
<b>9</b>	<b>Troubleshooting</b>	<b>14</b>
<b>10</b>	<b>Technical Data</b>	<b>15</b>
<b>11</b>	<b>Default settings</b>	<b>15</b>
<b>12</b>	<b>Topcom warranty</b>	<b>15</b>
12.1	Warranty period	15
12.2	Warranty handling	15
12.3	Warranty exclusions	15

## Safety Instructions

- Only use the charger plug supplied. Do not use other chargers, as this may damage the battery cells.
- Only insert rechargeable batteries of the same type. Never use ordinary, non-rechargeable batteries. Insert rechargeable batteries so they connect to the right poles (indicated in the battery compartment of the handset).
- Do not touch the charger and plug contacts with sharp or metal objects.
- The operation of some medical devices may be affected.
- The handset may cause an unpleasant buzzing sound in hearing aids.
- Do not place the basic unit in a damp room or at a distance of less than 1.5 m away from a water source. Keep water away from the handset.
- Do not use the telephone in environments where there is a risk of explosions.
- Dispose of the batteries and maintain the telephone in an environment-friendly manner.
- As this telephone cannot be used in case of a power cut, you should use a mains-independent telephone for emergency calls, e.g. a mobile phone.
- This telephone uses rechargeable batteries. You have to dispose of the batteries in an environment friendly manner according to your country regulations.

## Disposal of the device (environment)

At the end of the product lifecycle, you should not throw this product into the normal household garbage but bring the product to a collection point for the recycling of electrical and electronic equipments. The symbol on the product, user guide and/or box indicate this.

Some of the product materials can be re-used if you bring them to a recycling point. By re-using some parts or raw materials from used products you make an important contribution to the protection of the environment.

Please contact your local authorities in case you need more information on the collection points in your area.



## Cleaning

Clean the telephone with a slightly damp cloth or with an anti-static cloth. Never use cleaning agents or abrasive solvents.

# 1 Buttons

## Handset

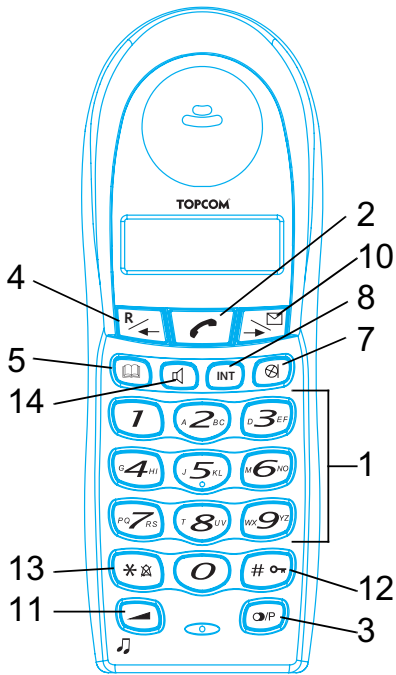

1. Numerical buttons
2. Line button
3. Redial / Pause button
4. Flash R/ Scroll **R**/
5. Memory button
6. Paging button (to retrieve the handset)
7. Mute button
8. Int button **Int**
9. Charge indicator (LED)
10. Call log/Scroll /
11. Volume/melody button /
12. Key lock
13. Ringer ON/OFF
14. Handsfree
15. Charge indicator (LED) multi charger

## Base

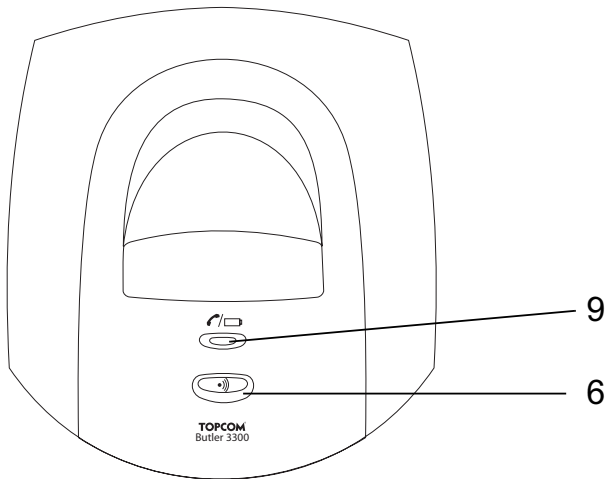

## Charger

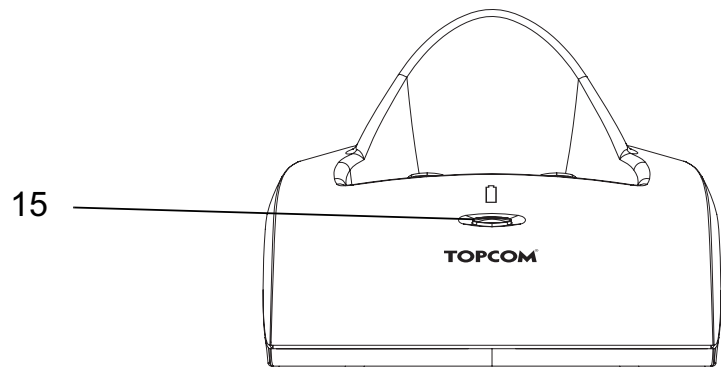

## 2 Display

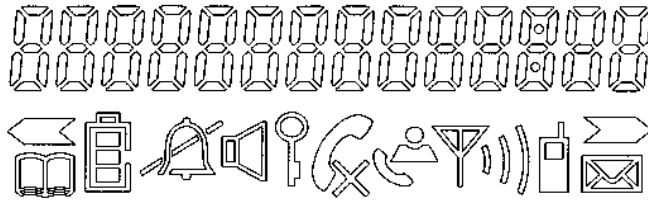

ICON:	MEANING:
	You are online
	New numbers in call list
	Rechargeable battery level indicator
	The antenna indicates the quality of reception. The antenna blinks when the handset is out of range!
	Microphone is muted
	Memory records are being retrieved or set up
	The keypad is locked
	There are more digits on the left
	There are more digits on the right
	During hands free
	When ring buzzer is turned off
	There are new messages in your voice mail
	During internal call
HS-x	x = handset number

## 3 Installation

### 3.1 Base

- Plug one end of the phone cable into the phone unit and the other end into the telephone line wall socket.
- Connect the small plug of the AC adaptor to the phone and the other end of the adapter cable to the electric socket.

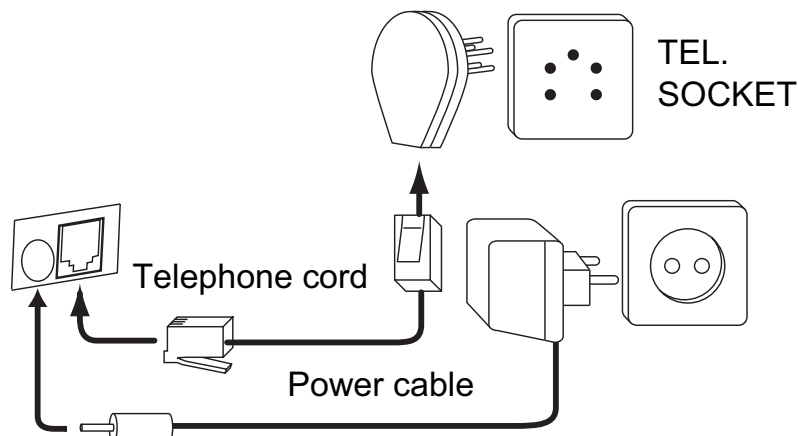

### 3.2 Multi charger

- Connect the AC adaptor to the electric socket

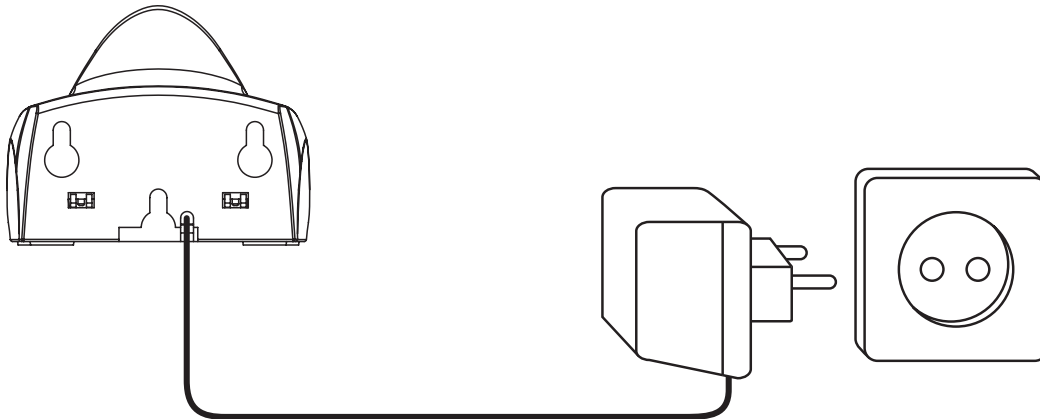

### 3.3 Handset

- Insert 2 rechargeable batteries (AAA) inside the battery compartment of the handset..

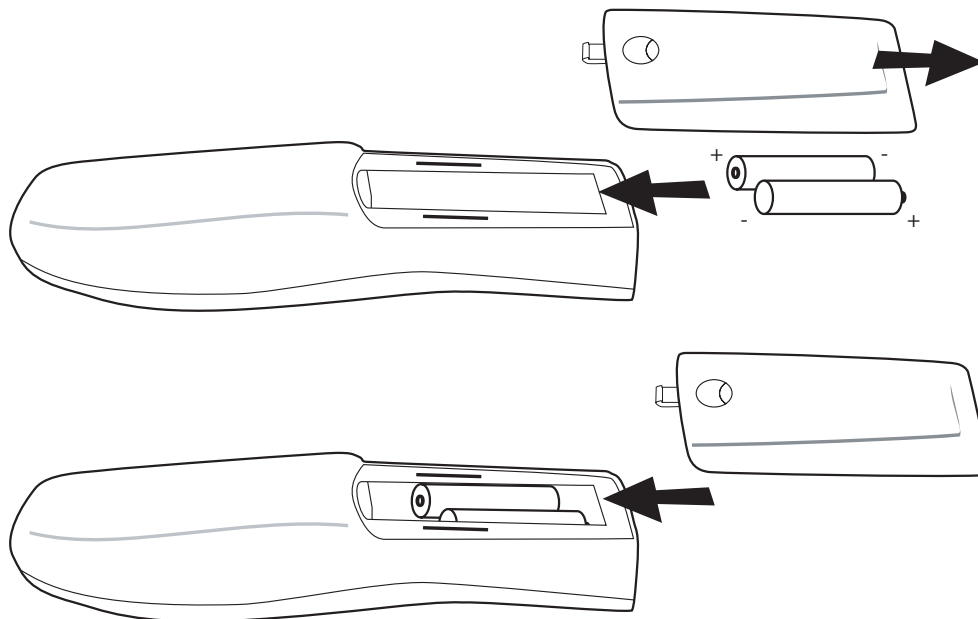



Put the handset on the base unit. The red Charge LED  will lit as long as the handset is on the base.

Charge the handset for a period of 24 hours before using the handset for the first time. To extend the battery life time, discharge the batteries completely from time to time. As soon as the handset emits a warning tone or when the battery icon  is empty, you have to put it back on the base unit for charging.

## 4 Battery low indication

When the battery is empty, the handset no longer carries out operations. When a battery is completely empty and you have put the handset on the base unit for a short period of time, the Battery symbol will appear to be fully charged but this is actually not the case. The battery capacity will decrease rapidly. We advise you to put the handset on the base unit for 12 hrs so that it can be recharged completely.



-  Full battery
-  Empty battery

When you are in the middle of a conversation and the battery is almost empty, the handset will emit a warning signal. Place the handset on the base unit to charge.



## 5 Operation

### 5.1 Outgoing calls



#### **5.1.1 Making a phone call**

- Press the Line button . You will hear the dial tone.
- Enter the desired telephone number.
- Press the Line button  when you want to terminate the call.





#### **5.1.2 Call setup with dial preparation**

- Enter the desired telephone number. An incorrect number can be corrected by means of the Mute  button . When you haven't pressed a button for 10 seconds, the number you've already entered will disappear and the handset returns to standby mode.
- Press the Line button . The number will be dialled automatically.
- Press the Line button  when you want to terminate the call.

#### **5.1.3 Redialling the last number dialled**



- Press the Line key .
- The Line/Charge indicator  (LED) on the base unit will blink.
- You will hear the dial tone.
- Press the Redial key . The number you last called is dialled automatically.

#### **5.1.4 Redial one of the last 3 numbers dialled**



- Press the Redial key . The number you last called appears on the display. If you would like to dial one of the last 3 numbers dialled, press the Redial key  a few times until the desired number appears on the display.
- Press the Line key .
- The number shown on the display is dialled automatically.
- After finishing your call, press the Line key  to hang up.



## 5.2 Incoming calls

- When a call comes in, the handset will start to ring. The  LED on the base will blink.
- Press the Line button  to answer the incoming call.

## 5.3 Activate/deactivate hands free function

This function allows you to communicate without having to pick up the handset. When you are on the phone, press the Hands free key  to activate the hands free function. Press the same button  to deactivate the hands free function.







**When you are calling in hands free mode and you want to change the volume, press the Volume button.**



**When you use the hands free function for a long time, the batteries will be empty more quickly !**

## 5.4 Programming memory numbers



You can program 10 indirect numbers (of max. 25 digits) in the phone's memory.

- Press and hold the Memory button  until the -icon appears on the display.
- Enter the telephone number you wish to store.
- Press the Memory button  again to confirm.
- Enter the memory location (0-9) where you want to store the number.
- You will hear a confirmation tone and the -icon will disappear.





**If you wish to insert a pause, press the Redial/Pause button  on the location where you want a pause of 3 sec.**

## 5.5 Calling a memory number

- Press the Memory button , followed by the number of the memory location (0-9).
- Press the Line button . The memory number will be dialled automatically.
- Press the Line button  when you want to terminate the call.

## 5.6 Mute function

It is possible to deactivate the microphone during a conversation. Now you can speak openly without being heard by your correspondent.

- Press the Mute button  during a conversation. The microphone will be deactivated. The MUTE symbol  appears on the display.
- Press the Mute button  again when you want to continue the conversation.

## 5.7 Setting the volume

During a conversation you can set the volume by pressing the Volume button . You can set the volume alternatively in Hi, Medium and Low.



**The hands free receiver volume is also adjustable as above described!**

## 5.8 Paging

When you press the Paging button  on the base unit, the handset emits a ringing signal for 20 seconds. This signal helps you find a lost handset. Press any key to stop the ringing on a handset.

## 5.9 Flash button (R)





When you press the R button, also called flash or recall, the unit generates a line interruption (of 100 ms or 250 ms). It gives you the possibility to use the special services of your telephone provider and/or to transfer calls when you have a telephone exchange.

### 5.9.1 Setting the Flash time



- Press and hold the redial button  for 3 sec.
- The display will show:  
‘S’ for 100ms  
or ‘L’ for 250ms
- The flash time setting will disappear after 2 sec. from the display

## 5.10 Setting the ring volume and melody

### 5.10.1 Handset melody

- Press and hold the melody button  until the current melody is heard.
- Select the desired melody (1-9) by means of the scroll keys   or by entering a number (1 - 9).
- Press  again to confirm the setting

### 5.10.2 Handset ring volume



- Press the volume button  in standby
- The handset will ring in the current volume
- Press 1-5 or use the scroll keys   to select the desired volume
- Press '0' to turn the volume OFF



- **You can turn the ringer volume of each individual handset ON or OFF by simply press and hold the  key in standby.**
- **The base unit will never ring!**

## 5.11 Key lock

When the keypad is locked, pressing any key will have no effect during standby (except holding the  key).

- Press and hold the  key
-  appears on the display and the keypad is locked
- Press and hold the  key again to un-lock the keypad

When there is an incoming call, you can still answer the call by pressing the Line button . During the call, the keypad functions as normal. When the call is ended, the keypad will be locked again

## 5.12 Setting the dialling mode

There are two types of dialling mode:

DTMF/Tone dialling (the most common) (default)

Pulse dialling (for older installations)

To change the mode of dialling:

- Press and hold the flash R button to toggle between dialling modes:  
‘P’ will appear when set to pulse or ‘T’ when set to tone (DTMF) dialling
- After 5 sec. the unit returns to standby



**You can change by accident the dial mode of the phone when pressing the recall/Flash key ‘R’ for 5 sec in standby. The wrong dialling mode will cause that the number isn’t dialled correctly or isn’t dialled at all.**

## 6 Caller-ID function (CLIP)

The Topcom B3300 displays the telephone numbers of incoming calls. This function is only possible if you are subscribed to a telephone operator that provides this service. Contact your telephone provider for more information. When you receive a call, the numbers are saved in a Call list. This list can hold 20 telephone numbers (each of max. 25 digits). If the number is longer than 14 digits, you can press the  key to show the other digits!

### 6.1 New calls

When you’ve received a new unanswered call, the CLIP symbol  will blink on the display.

### 6.2 Consulting the Call list

- Press the Call Log button . The last received call is shown on the display. If the list is empty, ‘NO CLIP’ is shown on the display.
- The following will be shown on the display:

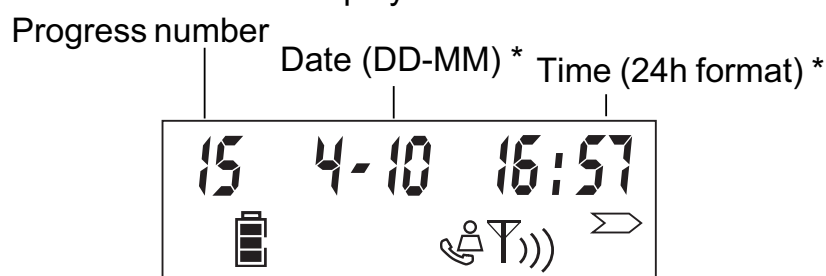

- After 5 seconds, the telephone number will be shown. You can skip the date/time by pressing the → button.
- Use the left scroll key ← to scroll to the previous call. Use the → button to show the next call.
- You can leave the Call list by pressing the ⊗ button.

**\* Only when the network sends the time/date together with the telephone number!!! On some networks with caller ID, time and date will not be displayed**

### 6.3 Calling a number from the Call list

- Scroll through the Call list until the desired number is shown on the display.
- Press the Line button ↷. The number will be dialled automatically.

### 6.4 Erasing a number from the Call list

- Scroll through the Call list until the desired number is shown on the display.
- Press and hold the Mute button ⊗ for 3 sec. to erase the number.

### 6.5 Store a number from the call log into the memory

- Scroll through the Call list until the desired number is shown on the display.
- Press and hold the Memory button 📖 for 3 sec.
- Enter the memory location (0-9) where you want to store the number
- Enter the Memory button 📖 again to confirm and to go back to standby

## 7 Register/de-register a handset

### 7.1 Register to a Topcom B3300 base

You can subscribe 4 handsets to one base unit. By default, each handset is subscribed as handset 1 on the base unit upon delivery (base unit 1).

!!! You only need to subscribe the handset if:

- The handset subscription has been removed from the base unit (e.g. for reinitialisation)
- You want to subscribe a different handset to this base unit.

The below procedure is only applicable to a Topcom Butler 33xx handset and base unit!!

Keep the Paging key on the base unit pressed for 10 seconds until the Line/Charge indicator on the base unit begins to blink rapidly. The Line/Charge indicator will blink rapidly for one minute. During this minute, the base unit is in register mode and you must do the following to subscribe the handset:

- Press and hold the → key for 3 sec, then press and hold the \* key for 3 sec.
- The following will appear on the display:



- Enter the number of the base unit you would like to subscribe the handset to (1-4)
- The unit will start searching for the base and when found it will ask to enter the pin code (4 digits):

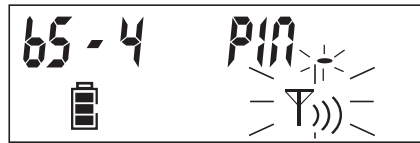

- Enter the base pin code (0000). If the pin is wrong, the handset will restart the searching for the base.
- When the handset is registered, it will show 'HS' followed by the handset number.

## 7.2 Subscribing a Topcom Butler 300 DECT GAP Headset

Press the Paging key on the base unit for 10 seconds until the Line/charge indicator on the base unit starts to blink quickly. The line/charge indicator will blink quickly for one minute. During this minute, the base unit is in subscribing mode and you must do the following to subscribe the headset:

- Turn ON the headset by pressing the ON/OFF button until you hear two beep tones. At the same time the red and green LED will lit ones.
- Remove the rubber cover of the power socket so that the hole of the power socket is free. Pull out the rubber cover from the headset so that the registration key hole is free also.
- Press the headset registration key. The red LED will flash rapidly.
  - If after a few seconds the green LED flashes slowly, the registration is successful.
  - If the red LED flashes slowly, the registration is failed. Repeat above procedure.

## 7.3 Removing a handset

You can remove a handset from a base to allow another handset to be registered:

- Press and hold the → key for 3 sec, then press and hold the ⊗ key for 3 sec.



- Enter the pin code (0000). If the pin is wrong, the handset will go back to standby.

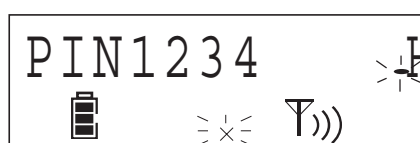

- Enter the handset number (1-4) you want to remove
- The unit will go back to standby if the removal is successful. If not, it will ask again to enter the handset number



**You can only remove existing handsets and others then the one you are using.**

## 8 Call transfer and Intercom between two handsets





**These functions only work when more then one handset (like a Twin/Triple/Quattro version) is registered to the base!**

### 8.1 Call transfer and conference call during an external call

- During an external call, press the INT key followed by the number (1-4) of the other handset.
- The other handset will start to ring:
  - When the other handset takes the line you can talk internally.  
If you hang up, the external line will be connected with the other handset.  
If you press and hold the INT key for 3 seconds you can talk with the 2nd handset and external line at the same time (conference call)
  - Or press the INT key again to return to the external call.
- Press the Line button  to end the call.

### 8.2 Internal call (intercom)

- In standby press the INT key followed by the number (1-4) of the other handset.
- The other handset will start to ring. You can stop the ringing by pressing the line button .
- If the other handset answers the call by pressing the Line button  you can talk internally.
- Press the Line button  to end the call.

## 9 Troubleshooting

Problem	Possible cause	Solution
No Display	Batteries not charged	Check the position of the batteries
		Recharge the batteries
No dialling tone	Telephone cable not properly connected	Check the connection of the telephone cable
Volume of conversation partner too low		Adjust the volume during the conversation by pressing the volume key
Handset ringer volume too low		Adjust the ringer volume
Not possible to dial a number	Wrong dial mode	See §5.13 to set the correct dial mode

## 10 Technical Data

Range:	up to 300 m in open space up to 50 m in buildings
Dialling options:	DTMF (tone) and Pulse
Batteries:	2 x 1.2V, 600 mAh AAA Type NiMH rechargeable
Max. standby time:	approx. 100 hours
Max. talk time:	11 hours
Ambient temperature:	+5 °C to +45 °C
Permitted relative air humidity:	25 to 85 %
Power supply base adapter:	220/230V , 50 Hz
Memories	10 indirect with max. 25 digits

## 11 Default settings

Flash time	100 ms
Dialling mode	Tone
Ring volume	Level 3
Ring melody	Ringer 8
Base pin	0000

## 12 Topcom warranty

### 12.1 Warranty period

The Topcom units have a 24-month warranty period. The warranty period starts on the day the new unit is purchased. The warranty on batteries is limited to 6 months after purchase. Consumables or defects causing a negligible effect on operation or value of the equipment are not covered.

The warranty has to be proven by presentation of the original purchase receipt, on which the date of purchase and the unit-model are indicated.

### 12.2 Warranty handling

A faulty unit needs to be returned to a Topcom service centre including a valid purchase note.

If the unit develops a fault during the warranty period, Topcom or its officially appointed service centre will repair any defects caused by material or manufacturing faults free of charge.

Topcom will at its discretion fulfil its warranty obligations by either repairing or exchanging the faulty units or parts of the faulty units. In case of replacement, colour and model can be different from the original purchased unit.

The initial purchase date shall determine the start of the warranty period. The warranty period is not extended if the unit is exchanged or repaired by Topcom or its appointed service centres.

### 12.3 Warranty exclusions

Damage or defects caused by incorrect treatment or operation and damage resulting from use of non-original parts or accessories not recommended by Topcom are not covered by the warranty.

Topcom cordless phones are designed to work with rechargeable batteries only. The damage caused by the use of non-rechargeable batteries is not covered under warranty.

The warranty does not cover damage caused by outside factors, such as lightning, water and fire, nor any damage caused during transportation.

No warranty can be claimed if the serial number on the units has been changed, removed or rendered illegible.

Any warranty claims will be invalid if the unit has been repaired, altered or modified by the buyer or by unqualified, non-officially appointed Topcom service centres.

# **TOPCOM<sup>®</sup>**

**visit our website**  
**[www.topcom.net](http://www.topcom.net)**

U8006440